

Data Sheet



Article number: 03492035

Description: Fluro Heavy Duty Rod end EIL 35 EW-2RS
M36x3 Female thread

Note: 35

Measures

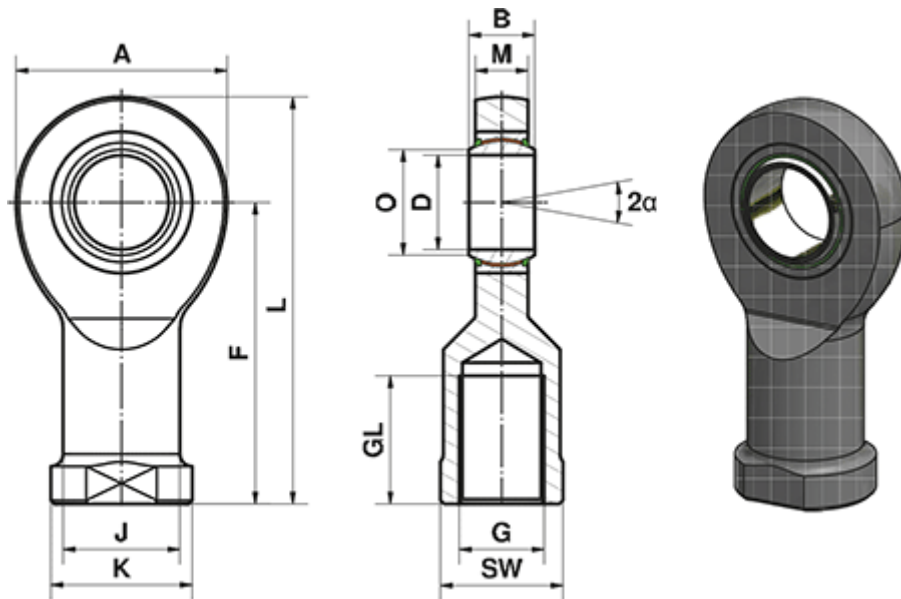

A	= 82	J	= 47
a (degrees)	= 6	K	= 58
B	= 25	L	= 166
D	= 35	M	= 21
Dynamic load C (kN)	= 210	O	= 39.8
F	= 125	Static load C0 (kN)	= 144
G	= M36x3	SW	= 50
GL	= 60	Weight (g)	= 1300